BuzziHug

Product Specification Sheet

This document contains technical information about the BuzziHug



www.buzzi.space









A versatile privacy booth for the ever-changing workspace

BuzziHug is a semi-enclosed privacy booth that instantly creates a cozy and safe working environment for employees to hold video calls or to get focused work done. Due to its voluminous upholstered body, BuzziHug effectively mitigates excessive noise while doubling as an unexpected design element within any workspace. BuzziHug is equipped with a built-in table in either Antwerp Oak or White Laminate. Select an optional LED light with two USB charging ports so you can keep your laptop, smartphone, and other devices charged at all times. Due to its lightweight and flexible attributes, BuzziHug can be placed anywhere in an open space. Built with a sturdy core and adjustable feet, BuzziHug can also be bolted to the ground to prevent it from falling over during earthquakes and seismic shocks.

Design by BuzziSpace Studio

General

-  BuzziHug
-  Upholstered acoustic foam element with wooden structure
-  Tablet: Antwerp Oak or White Laminate
-  Fabrics: Fabric, Trevira CS+ | CS, Revive 1, Remix 3, Clara 2, Hero, Tonus 4 or Memory 2
-  Dry Use
-  Assembled
-  LED light in black aluminium with two USB chargers

Certifications

Light: CE/CB, cULus Listed E473379

Acoustics



Absorption



Attenuation



Low Tone



Mid Tone



High Tone

Content

Configurations	3
Components	4
Options	5
Photometric Data	5
Fabrics	6
Dimensions	9

Configuration

BuzziHug

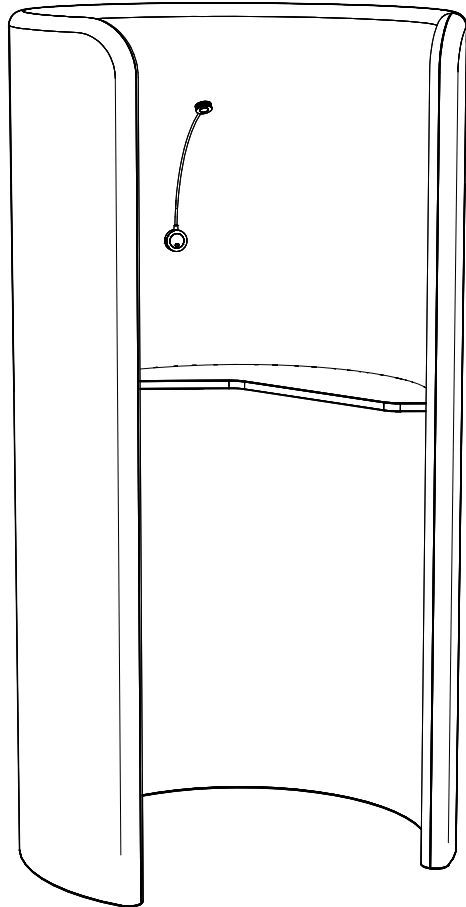

Upholstered acoustic foam element with wooden structure
Tablet: Antwerp Oak or White Laminate
Fabrics: Fabric, Trevira CS+ | CS, Revive 1, Remix 3, Clara 2, Hero, Tonus 4 or Memory 2

Length: 100 cm | 39.37"
Width: 100 cm | 39.37"
Height: 190 cm | 74.80"
Height Worktop: 105 cm | 41.34"

33 kg | 72.75 lbs

LED light in black aluminium with two USB chargers
Switch: built-in switch with 2 light levels
USB: 2x USB charging 5V/2A
Wattage: max 17 (light: 1,5) W
Input Voltage: 12V
Lumen Output: 105 lumen
Color Temperature: 4000K
Color Rendering Index: 82
Energy Efficiency Class: A+
Material: aluminium

Components

Tablet



Antwerp Oak: These solid wood tablet may contain knots, natural color variations and drying splits as normal features of the product. This contributes to the uniqueness of each tablet.

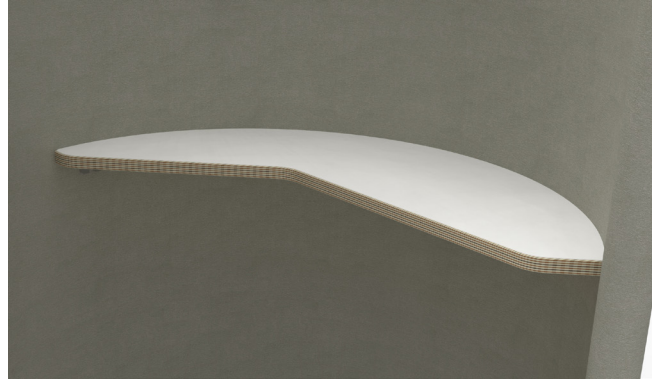

White Laminate with birch multiplex core

Feet

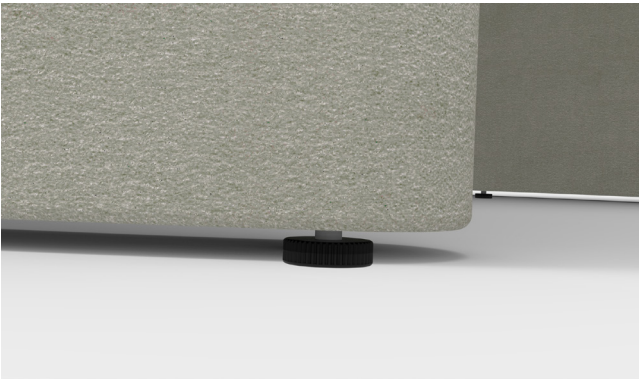

4 adjustable feet are included

Fixing plates



BuzziHug can be bolted to the ground to prevent it from falling over during earthquakes and seismic shocks.

2 fixing plates are included
(powder coated metal in black RAL 9005)

Options

Light Source



Black wall light with flexible neck
Switch: built-in switch with 2 light levels
USB: 2x USB charging 5V/2A
Wattage: max 17 (light: 1,5) W
Input Voltage: 12V
Lumen Output: 105 lumen
Color Temperature: 4000K
Color Rendering Index: 82
Energy Efficiency Class: A+
Material: aluminium

Certification: CE | cULus Listed E473379

Power Adapter



Power Adapter available for US/EU
EU-UK converter available for UK
Included Power Cord 2 m | 78.74"

Photometric Data

Light Source

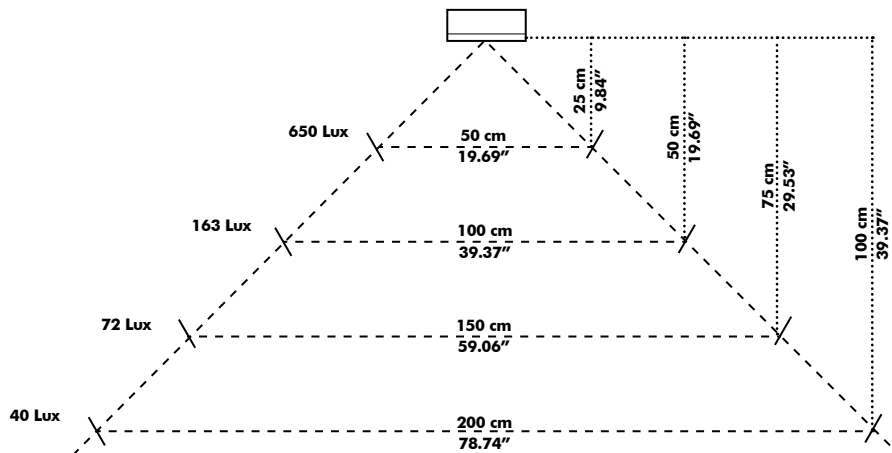

Fabrics

Fabric

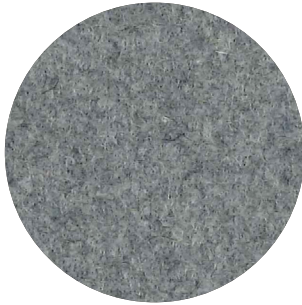

Category A

Composition 70% Recycled Wool, 25% Recycled Polyacryl,
5% Recycled Other Fabrics

Weight 405 g/m² | 11.94 oz/yd²

Abrasion resistance 40.000 Martindale, 50,000 Wyzenbeek

Flammability EU: EN 1021.1/2006 | BS EN 1021.1/2006 (cigarette).
EN 1021.2/2006 | BS EN 1021.2/2006 (match)
USA: CAL TB 117 | ASTM E84 CLASS A

Fastness to light EU: 4 | USA 4

Fastness to rubbing EU: Wet 3-4 | Dry 4-5

Fastness to crocking USA: Wet 5 | Dry 5



Trevira CS+ | CS

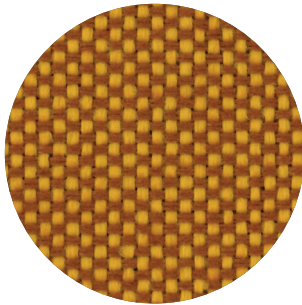

Category A

Weight 420 g/m² | 12.39 oz/yd²

Composition 100% Polyester, Trevira CS

Abrasion resistance 100.000 Martindale, 90,000 Wyzenbeek

Flammability BS 5852 part II: CRIB 5 | BS 7176 Medium Hazard
USA: CAL TB 117 | M1 | B1 | EN 1021/1-2 | C1 |
IMO Res. A652 (16)

Fastness to light EU: 6 | USA 5

Fastness to rubbing EU: Wet 4-5 | Dry 4-5

Fastness to crocking USA: Wet 5 | Dry 5



Revive 1

kvadrat

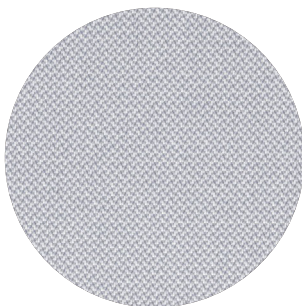

Category A

Composition 100% recycled polyester FR

Weight 430 g/lin.m

Abrasion resistance 60.000 Martindale rubs, EN ISO 12947

Flammability EN 1021-1/2 | DIN 4102 B1 | Önorm B1/Q1
UNI 9175 1IM | US Cal. Tech. Bull. 117
IMO A.652 (16)

Fastness to light Note 5-7, ISO 105-B02

Fastness to rubbing (ISO) dry 5, wet 4-5

Pilling Note 4-5, EN ISO 12945



Clara 2

kvadrat

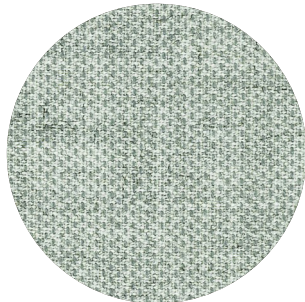

Category B

Composition 92% new wool, 8% nylon

Weight 400 g/lin.m

Abrasion resistance 80.000 Martindale rubs, EN ISO 12947

Flammability EN 1021-1/2 | BS 5852, ignition source 2-3 | DIN 4102 B2
NF D 60 013 | UNI 9175 11M | US Cal. Tech. Bull. 117, Sec. E
NFPA 260 | IMO A.652(16)

Fastness to light Note 5-7, ISO 105-B02

Fastness to rubbing (ISO) dry 4-5, wet 4

Pilling Note 4, EN ISO 12945



Remix 3

kvadrat



Category B

Composition 90% new wool, 10% nylon

Weight 415 g/lin.m

Abrasion resistance 100.000 Martindale rubs, EN ISO 12947

Flammability EN 1021-1/2 | BS 5852 part 1
Önorm B1/Q1 | NF D 60 013 | UNI 9175, 11M
AS/NZS 1530.3 | Cal. Tech. Bull. 117-2013
NFPA 260 | IMO FTP Code 2010:Part 8

Fastness to light Note 5-7, ISO 105-B02

Fastness to rubbing (ISO) dry 4-5, wet 4

Pilling Note 4, EN ISO 12945



Hero

kvadrat

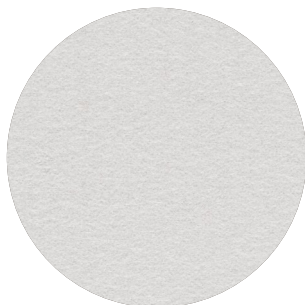

Category C

Composition 96% new wool, 4% nylon

Weight 580 g/lin.m

Abrasion resistance 45.000 Martindale rubs, EN ISO 12947

Flammability EN 1021-1/2 | DIN 4102 B2 | NF D 60 013
UNI 9175 11M | US Cal. Bull. 117-2013 | NFPA 260
IMO A.652 (16)

Fastness to light Note 5-6, ISO 105-B02

Fastness to rubbing (ISO) dry 4-5, wet 4-5

Pilling Note 3-4, EN ISO 12945



Tonus 4

kvadrat



Category D

Composition 90% new wool, 10% Helanca

Weight 665 g/lin.m

Abrasion resistance 100.000 Martindale rubs, EN ISO 12947

Flammability EN 1021-1/2 | BS 5852 part 1 | DIN 4102 B2

Önorm B1/Q1 | NF D 60 013 | UNI 9175 11M

US Cal. Bull. 117-2013 | NFPA 260 | IMO A.652 (16)

Fastness to light Note 5-7, ISO 105-B02

Fastness to rubbing (ISO) dry 3-5, wet 3-5

Pilling Note 3, EN ISO 12945



Memory 2

kvadrat

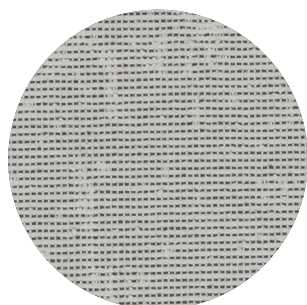

Category E

Composition 100% Trevira CS

Weight 700 g/lin.m

Abrasion resistance

35.000 rubs acc. to the Martindale method, EN ISO 12947

Flammability EN 1021-1/2 | DIN 4102 B1 | Önorm B1/Q1

NF D 60 013 | NF P 92 507 M1 | UNI 9175 11M

UNI 9177 classe 1 | US Cal. Tech. Bull. 117

IMO A.652 (16)

Fastness to light Note 5-8, ISO 105-B02

Fastness to rubbing (ISO) dry 4-5, wet 4-5

Pilling Note 4, EN ISO 12945



Dimensions

BuzziHug

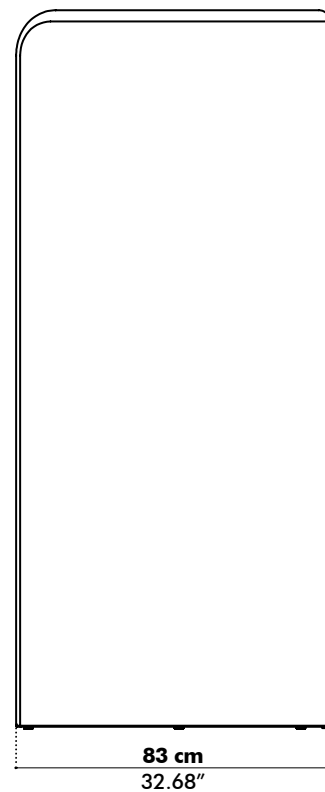
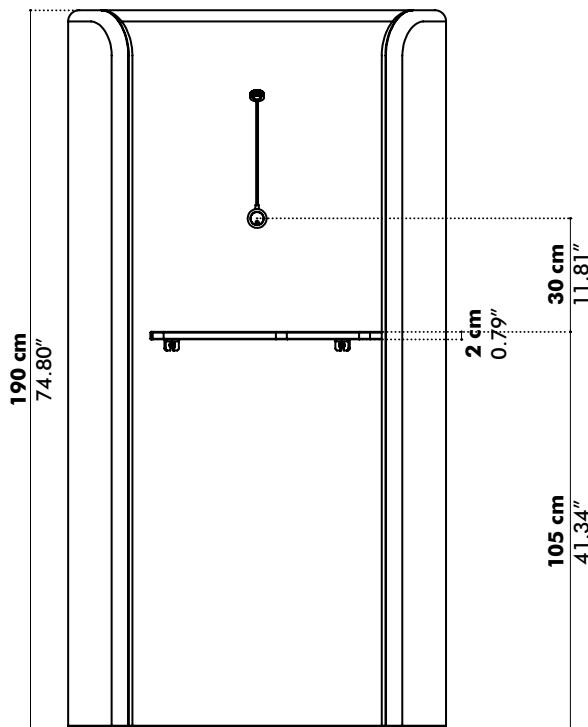
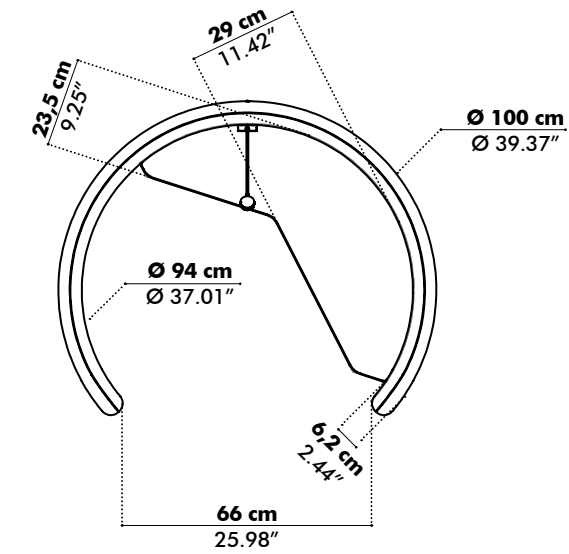

Fixing plates

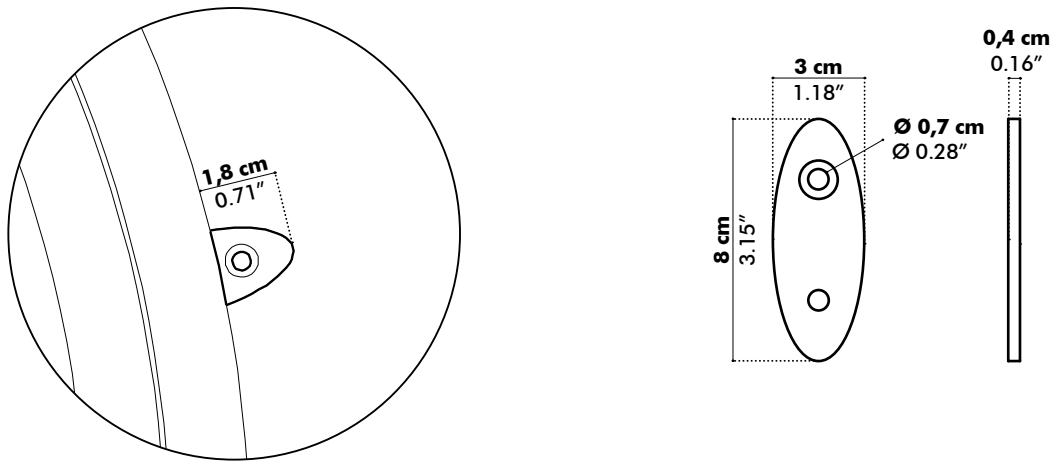

Light Source

